



MPO Cabling Solutions

Technologies & Design MPO

Types de traversées 12 fibres

- **Type A (noir)**

Key-up à Key-down

⇒ Pin 1 ⇒ Pin 1

⇒ Pin 12 ⇒ Pin 12

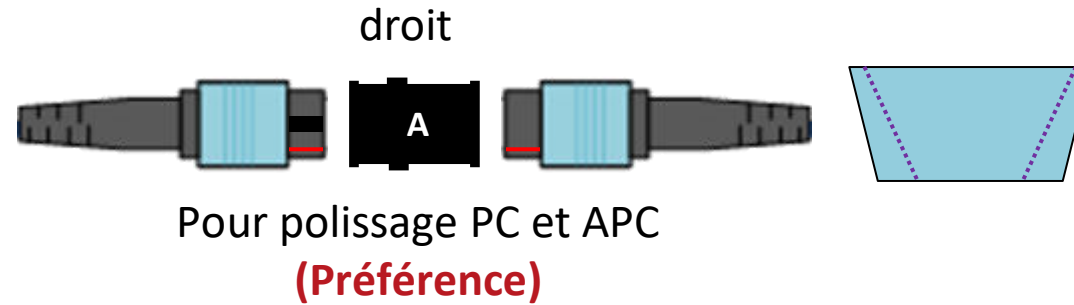

- **Type B (gris)**

Key-up à Key-up





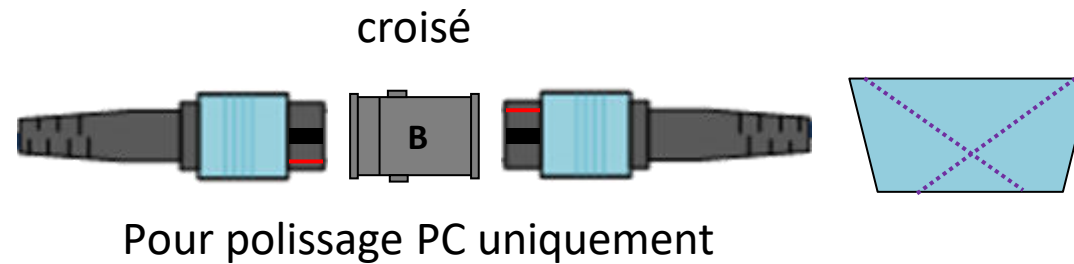







⇒ Pin 1 ⇒ Pin 12

⇒ Pin 12 ⇒ Pin 1



Connecteur MPO QR

- Deux types
 - Mâle avec broches de guidage
 - Femelle sans broches de guidage
- Coloration standardisée des fibres

1		Blue
2		Orange
3		Green
4		Brown
5		Slate
6		White
7		Red
8		Black
9		Yellow
10		Violet
11		Rose
12		Aqua



Avec pins (mâle)



Sans pins (femelle)

Câblage méthode A

Polarisation asymétrique

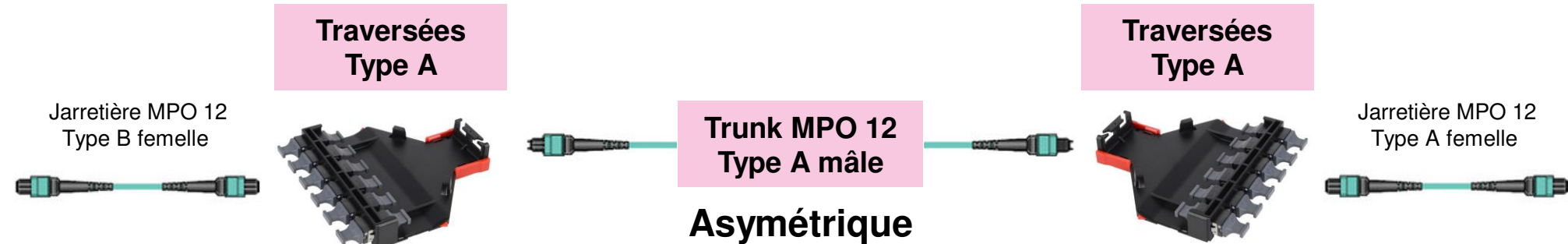
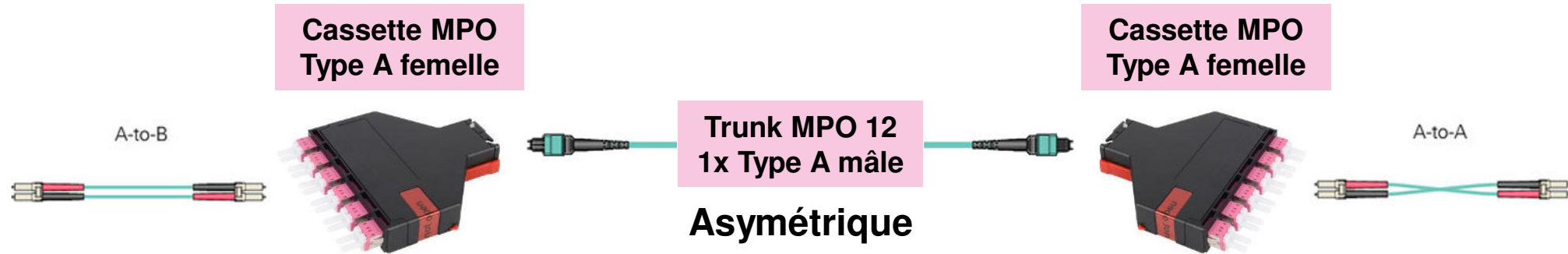

Câblage méthode A (recommandée)

Polarisation asymétrique

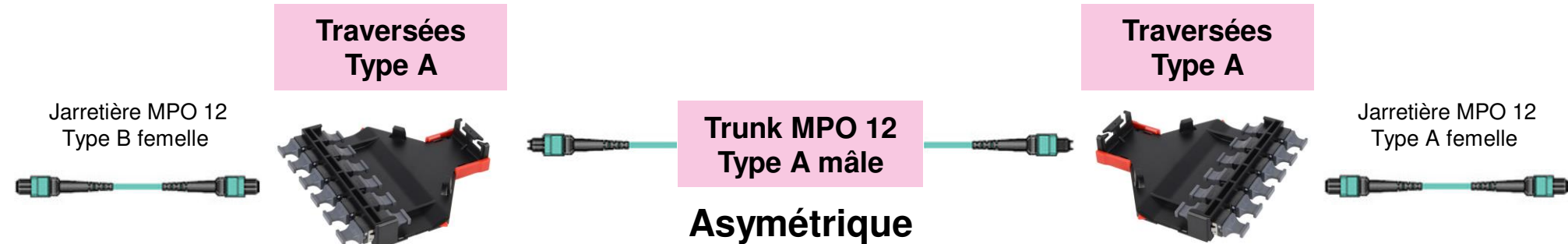
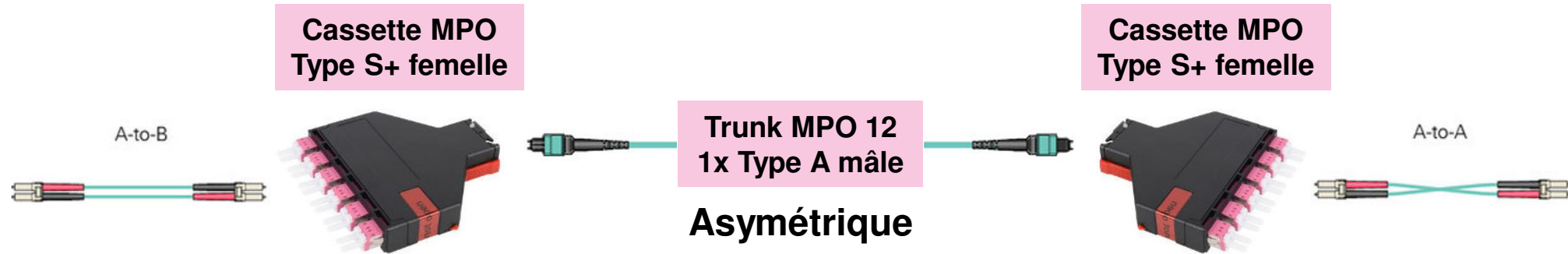

Câblage méthode S+ (recommandée)

Polarisation symétrique

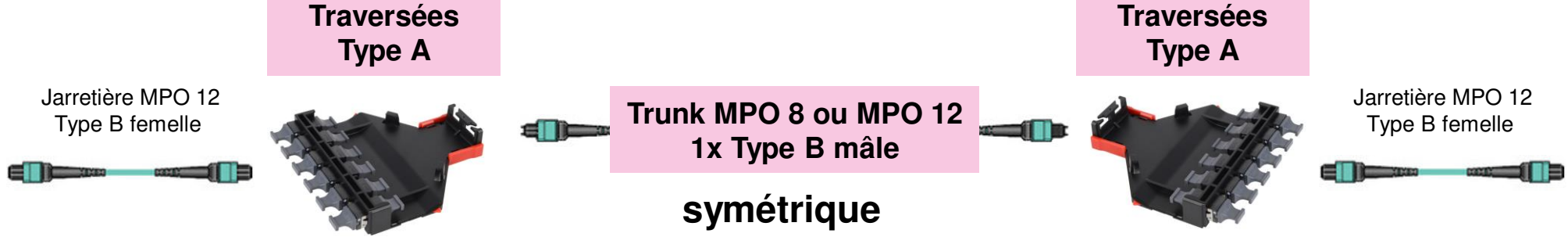

(1x8fo / 1x12fo / 2x12fo / 3x12fo)

Câblage méthode S

Polarisation symétrique

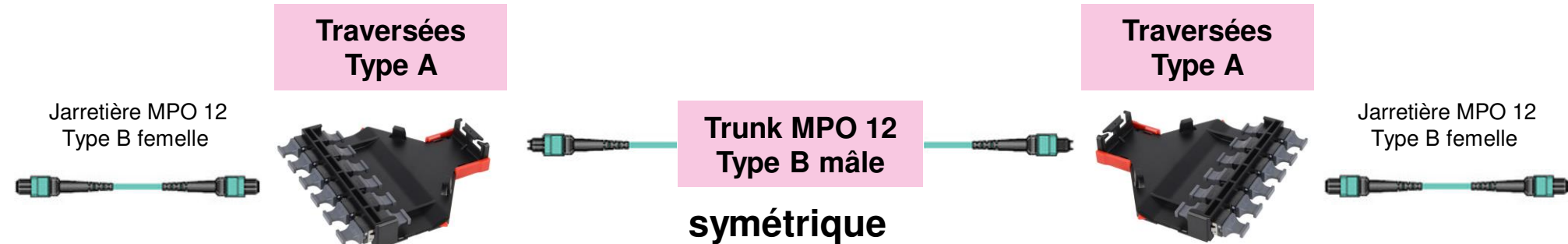

Solutions : Netscale 48

Capacité max. 48x LCD sur 1U



Module 6x LC Duplex
1x MPO 12 FO femelle
Type A / Type S+
OM4 / OM5 / OS2



Module 12x LC Duplex
2x MPO 12 FO femelle
Type A / Type S / Type S+
OM4 / OM5 / OS2

Solutions : Netscale 120

Capacité max. 90x LCD sur 1U



Capacité max. 360x LCD sur 3U

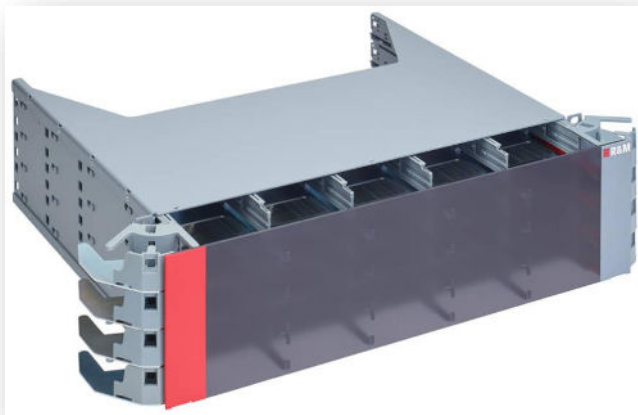

Module 6x LC Duplex
1x MPO 12 FO femelle
Type A / Type S+
OM4 / OM5 / OS2



Module 12x LC Duplex
2x MPO 12 FO femelle
Type A / Type S / Type S+
OM4 / OM5 / OS2



Module 18x LC Duplex
3x MPO 12 FO femelle
Type A / Type S / Type S+
OM4 / OM5 / OS2

Solutions : Netscale 72

Capacité max. 72x LCD sur 1U

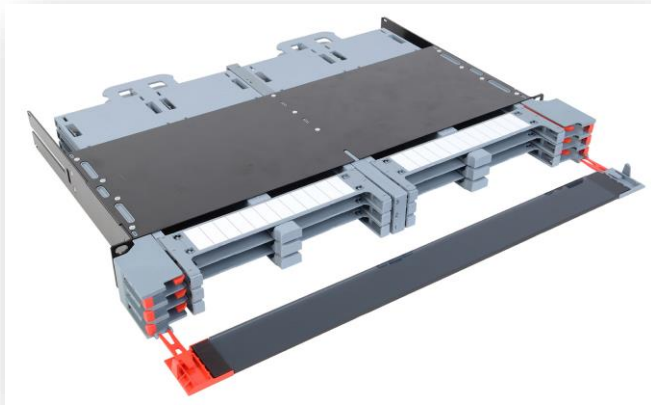

Module 6x LC Duplex
1x MPO 12 FO femelle
Type S+
OM4 / OM5 / OS2



Module 4x LC Duplex
1x MPO 8 FO femelle
Type S+
OM4 / OM5 / OS2

Solutions : Trunks / Harness MPO QR



Type A / Type B
MPO QR Femelle / MPO QR Mâle
8 / 12 / 24 / 36 / 48 / 72 / 96 / 144 FO
OM3 / OM4 // OM5 / OS2

Reichle & De-Massari AG
Binzstrasse 32
8620 Wetzikon
Switzerland

